

CT Series

DIN W48×H48mm, W72×H36mm, W72×H72mm counter/timer

Upgrade

■ Upgraded functions

- Available to set 6 digits(0.00001 to 999999) prescale value (4digit : 0.001 to 9999)
- Built-in Modbus communication function(Communication model)
- Available to set the One-Shot output time in 10ms. (0.01sec. to 99.99sec.)
- Increase contact capacity to 5A(CTS, CTM Series)
- Available to set Count Start Point.(Initial value)
- Improved to select memory protection function in the indicator
- Added BATCH counter function(CTM Series)
- Added Counter Up-1 / Up-2 / Down-1 / Down-2 input modes
- Added Counter TOTAL / HOLD operation modes in the indicator
- Added Timer TOTAL / HOLD / On Time Display operation modes in the indicator
- Added Timer INT2 / NFD / NFD.1 / INTG output modes
- Added Timer range 999.999s / 9999m59 / 99999.9h



⚠ Please read "Caution for your safety" in operation manual before using.



■ DAQMaster(integrated device management program)

- DAQMaster is a integrated device management program for convenient management of parameters and multiple device data monitoring.
- Visit our website (www.autonics.com) to download user manual and integrated device management program.

< DAQMaster screen >



Item	Minimum requirements
System	IBM PC compatible computer with Intel Pentium III or above
Operating system	Microsoft Windows 98/NT/XP/Vista/7
Memory	256MB or more
Hard disk	More than 1GB of free hard disk space
VGA	1024×768 or higher resolution display
Others	RS-232 serial port(9-pin), USB port

■ Ordering information

CT 6 M - 2P 4 T



Item	Digit	Size	Output	Power supply	Communication
4	6	S	2P	4	No mark
6		Y	1P	2	T
CT		M	I		

※A shaded () part is upgraded or added function.	
None	None
RS 485	RS 485
100-240VAC 50/60Hz	100-240VAC 50/60Hz
24VAC 50/60Hz / 24-48VDC	24VAC 50/60Hz / 24-48VDC
Dual preset	Dual preset
Single preset	Single preset
Indicator	Indicator
DIN W48×H48mm	DIN W48×H48mm
DIN W72×H36mm	DIN W72×H36mm
DIN W72×H72mm	DIN W72×H72mm
9999(4digit)	9999(4digit)
999999(6digit)	999999(6digit)
Counter/Timer	Counter/Timer

※4digit type does not exist in the indicator type.

Programmable Counter/Timer

■ Specifications

Series		CTS		CTY		CTM	
Digit		4		6		6	
Model	Dual Preset	CT4S-2P□□	CT6S-2P□□	CT6Y-2P□□	CT6M-2P□□		
	Single Preset	CT4S-1P□□	CT6S-1P□□	CT6Y-1P□□	CT6M-1P□□		
	Single Preset	—	CT6S-1□□□	CT6Y-1□□□	CT6M-1□□□		
Digit Size	Single Preset	11mm	10mm	10mm	13mm		
	Single Preset	8mm	7mm	7mm	9mm		
Power Supply	Single Preset	100-240VAC 50/60Hz					
	Single Preset	24VAC 50/60Hz / 24-48VDC					
Allowable voltage range		90 to 110% of rated voltage(AC Power type)					
Power consumption	Single Preset	Max. 12VA					
	Single Preset	AC: Max. 10VA / DC: Max. 8W					
INA/INB Max. counting speed		Selectable 1cps / 30cps / 1kcps / 5kcps / 10kcps					
Min. input signal width	Counter	Reset signal : Selectable 1ms, 20ms					
	Timer	INA, INB RESET : Selectable 1ms, 20ms				INA, INH, RESET, INHIBIT, BATCH RESET : Selectable 1ms, 20ms	
Input		Selectable voltage input or No-voltage input [Voltage input] Input impedance is 5.4kΩ, 'H' level : 5-30VDC, 'L' level : 0-2VDC [No-voltage input] Short-circuit impedance : Max. 1kΩ, Residual voltage : Max. 2VDC					
One-shot output		Count, timer : Selectable 0.01s to 99.99s					
Control output	With-out com.	Contact output	Dual preset : SPST(1a) 2EA Single preset : SPDT(1c) 1EA		Dual preset : SPST(1a) 1EA, SPDT(1c) 1EA Single preset : SPDT(1c) 1EA		
		Solid state output	Dual preset : 1NPN open collector Single preset : 1NPN open collector		Dual preset:3NPN open collector Single preset:2NPN open collector		
	With-out com.	Contact output	Dual preset : SPST(1a)2EA Single preset : SPDT(1c)1EA		Dual preset: SPST(1a), SPDT(1c) Single preset: SPDT(1c)		
		Solid state output	—		Dual preset: - Single preset:1NPN open collector		Dual preset:2NPN open collector Single preset:2NPN open collector
	With-out com.	Contact output	250VAC 5A resistive load		250VAC 3A resistive load		250VAC 5A resistive load
		Solid state output	30VDC Max. 100mA Max.				
External sensor power		12VDC ±10%, 100mA Max.					
Memory retention		10years(When using non-volatile semiconductor memory type)					
Timer	Repeat error	Power ON Start : Max. ±0.01% ±0.05 sec					
	SET error	Signal Start : Max. ±0.01% ±0.03 sec					
	Voltage error						
	Temperature error						
Insulation resistance		Min. 100MΩ(500VDC Megger)					
Dielectric strength		2,000VAC 50/60Hz for 1minute					
Noise strength (AC Power)		±2kV the square wave noise(pulse width:1μs) by the noise simulator					
Vibration	Mechanical	0.75mm amplitude at frequency of 10 to 55(for 1 min.)Hz in each of X, Y, Z directions for 1 hour					
	Malfunction	0.5mm amplitude at frequency of 10 to 55Hz(for 1 min.) in each of X, Y, Z directions for 10 minutes					
Shock	Mechanical	300m/s ² (approx. 30G) in each of X, Y, Z directions for 3 times					
	Malfunction	100m/s ² (approx. 10G) in each of X, Y, Z directions for 3 times					
Relay Life cycle	Mechanical	Min. 10,000,000 operations					
	Electrical	Min. 100,000 operations					
Protection		IP65(Front panel only)					
Environment	Ambient temperature	-10 to 55°C, storage : -25 to 65°C					
	Ambient humidity	35 to 85%RH, storage : 35 to 85%RH					
Approval		CE   					
Unit weight		Approx. 159g		Approx. 149g		Approx. 253g	

※Environment resistance is rated at no freezing or condensation.

■ Communication specification

Protocol	Modbus RTU(16bit CRC)
Connection method	RS485
Application standard	Compliance with EIA RS485
Number of connections	31, it is available to set address 1 to 127
Communication method	Half Duplex
Synchronous method	Asynchronous
Communication distance	within max. 800meter
Communication speed	2,400/4,800/9,600/19,200/38,400bps(Factory default : 9,600bps)
Response waiting time	5 to 99ms(Factory default : 20ms)
Start bit	1bit(Fixed)
Data bit	8bits(Fixed)
Parity bit	None, Even, Odd(Factory default : None)
Stop bit	1, 2bit(Factory default : 2bit)

(A)
Photo
electric
sensor

(B)
Fiber
optic
sensor

(C)
Door/Area
sensor

(D)
Proximity
sensor

(E)
Pressure
sensor

(F)
Rotary
encoder

(G)
Connector/
Socket

(H)
Temp.
controller

(I)
SSR/
Power
controller

(J)
Counter

(K)
Timer

(L)
Panel
meter

(M)
Tacho/
Speed/
Pulse
meter

(N)
Display
unit

(O)
Sensor
controller

(P)
Switching
mode power
supply

(Q)
Stepper
motor&
Driver&Controller

(R)
Graphic/
Logic
panel

(S)
Field
network
device

(T)
Software

(U)
Other

CT Series

Connections

! Be careful that connections are different between communication model and non-communication model when wiring.

CT□S-2P□

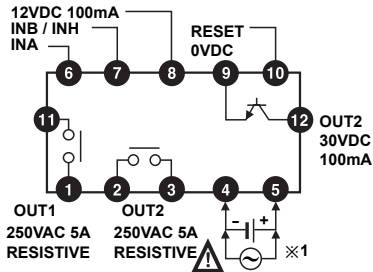

CT□S-2P□T

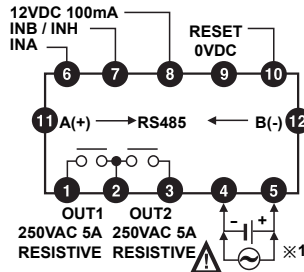

CT□S-1P□

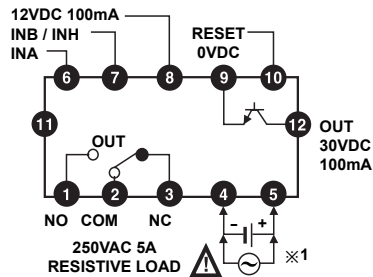

CT□S-1P□T

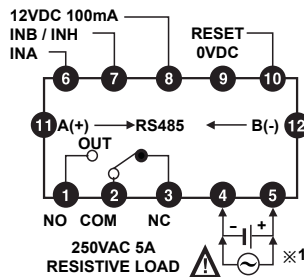

CT6S-I□

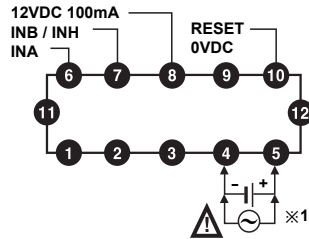

CT6S-I□T

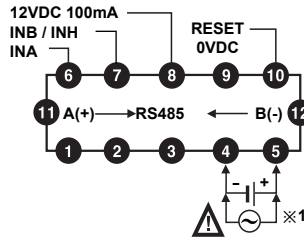

CT6Y-2P□

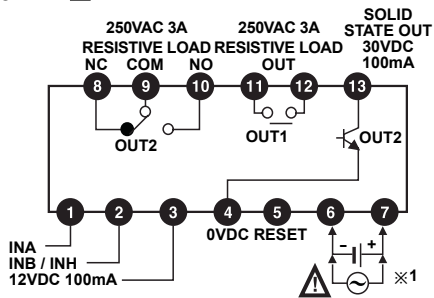

CT6Y-2P□T

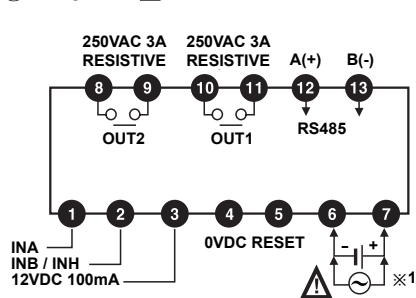

CT6Y-1P□

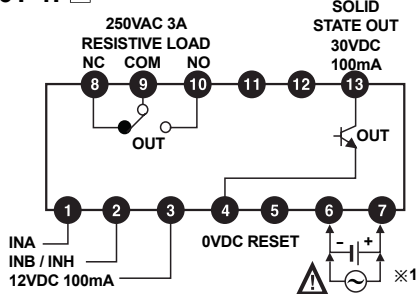

CT6Y-1P□T

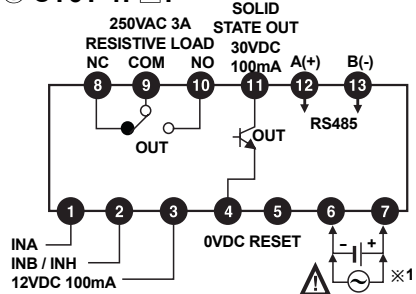

Programmable Counter/Timer

○ CT6Y-I □

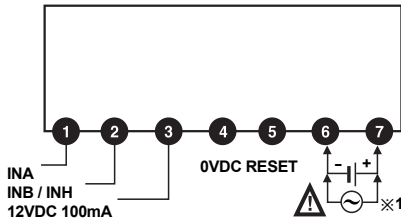

○ CT6Y-I □ T

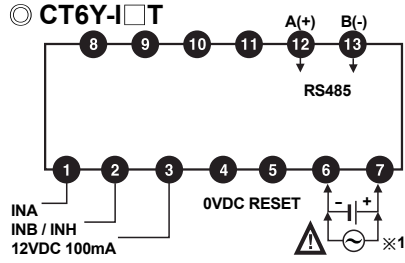

○ CT6M-2P □

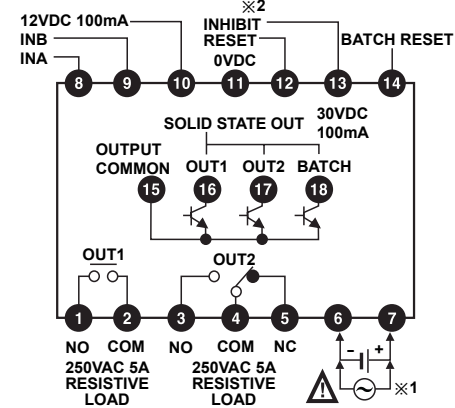

○ CT6M-2P □ T

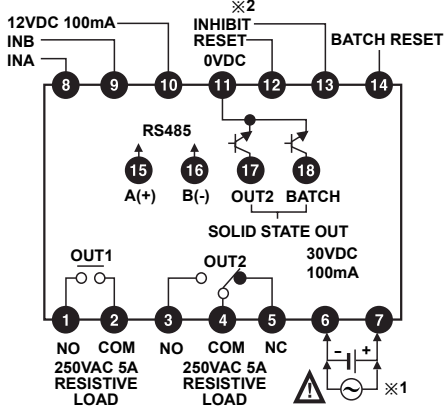

○ CT6M-1P □

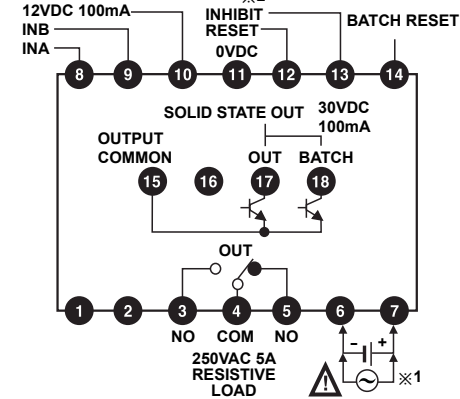

○ CT6M-1P □ T

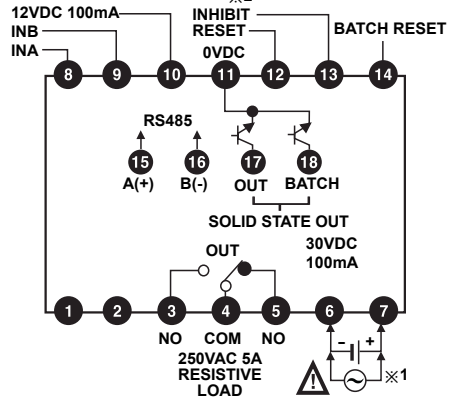

○ CT6M-I □

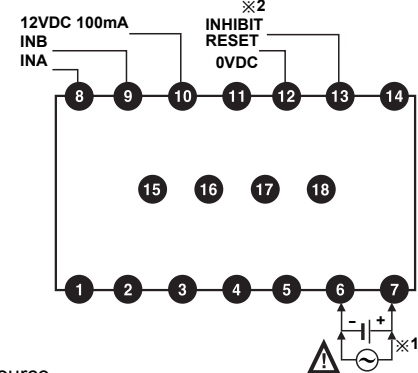

○ CT6M-I □ T

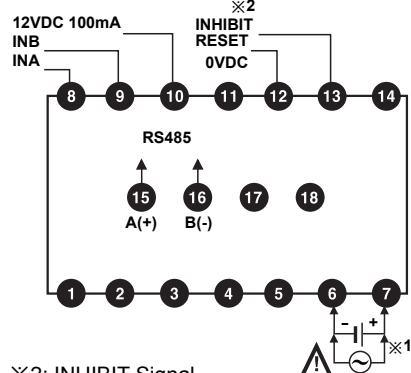

※1: Source
 - AC Power: 100-240VAC 50/60Hz
 - AC/DC Power: 24-48VDC, 24VAC 50/60Hz

※2: INHIBIT Signal
 - Counter operation: If INHIBIT signal is applied, count input will be prohibited.
 - Timer operation: If INHIBIT signal is applied, time progressing will stop.(HOLD)

(A)	Photo electric sensor
(B)	Fiber optic sensor
(C)	Door/Area sensor
(D)	Proximity sensor
(E)	Pressure sensor
(F)	Rotary encoder
(G)	Connector/ Socket
(H)	Temp. controller
(I)	SSR/ Power controller
(J)	Counter
(K)	Timer
(L)	Panel meter
(M)	Tacho/ Speed/ Pulse meter
(N)	Display unit
(O)	Sensor controller
(P)	Switching mode power supply
(Q)	Stepper motor& Driver&Controller
(R)	Graphic/ Logic panel
(S)	Field network device
(T)	Software
(U)	Other

CT Series

(unit:mm)

Dimensions

CTS Series

Bracket

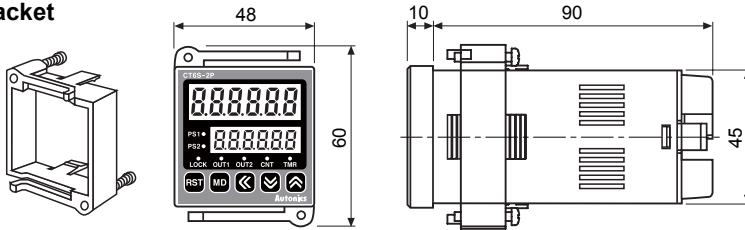

Panel cut-out

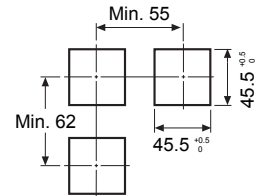

CTY Series

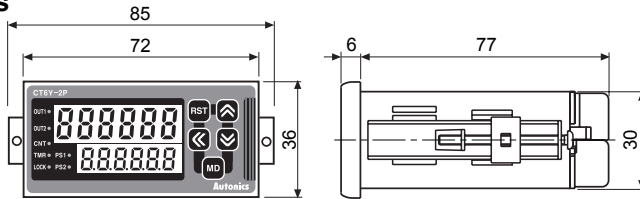

Panel cut-out

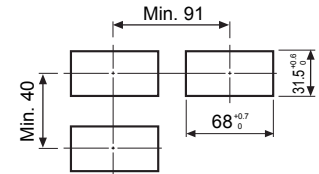

CTM Series

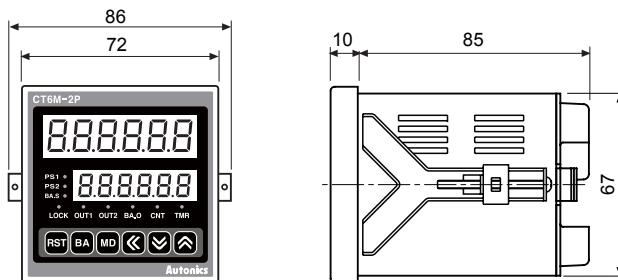

Panel cut-out

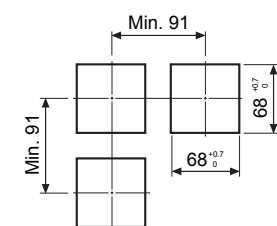

Parts description

CTS Series

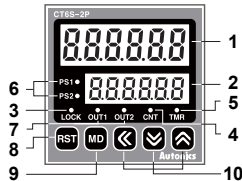

CTY Series

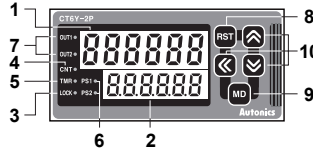

CTM Series

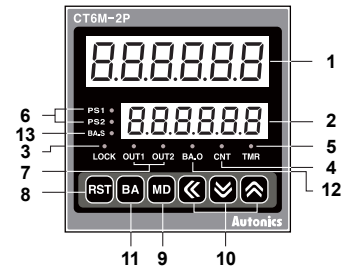

1. Count indicator(Red LED)

- Run mode
- Count mode-Indicates count value.
- Timer mode-Indicates time progressing.
- Function setting mode
- Indicates function setting mode.

2. Preset value indicator (Yellow-Green LED)

- Run mode: Indicates preset value.
- Function setting mode: Indicates setting value1.

3. Key Lock : Lights when setting key lock.

4. The operation of counter indicator

5. The operation of timer indicator

- TMR LED flashes when the timer is operating.
- TMR LED lights when the operating time stops.

6. Check preset value and display change of it

- PS1 LED lights when checking or changing the setting value1.
- PS2 LED lights when checking or changing the setting value2.

7. Output(OUT1, OUT2) indicator

- OUT1 lights when output1 is on.
- OUT2 lights when output2 is on.

8. Reset key

- By pressing **RST** key in Run mode, the count value is initialized and output is returned.

- By pressing **RST** key in BATCH counter mode, BATCH count value resets.

Model	Changed	Notice
CT6Y-1P		
CT6S-1P	PS2→PS	There are no PS1, OUT1 LEDs.
CT4S-1P	OUT2→OUT	
CT6M-1P		
CT6Y-I		
CT6S-I	PS2→PS	There are no PS1, OUT1 OUT2 LEDs.
CT6M-I		

※The indicator type does not exist in CT4S model.

9. Mode key

- By pressing **MD** key for 3sec (parameter setting)/ 5sec (communication) in RUN mode, it moves to function setting mode.
- By pressing **MD** key in function setting mode, select function setting mode. By pressing **MD** key over 3 sec., it moves to Run mode.
- By pressing **MD** key over 1 sec. in function setting checking mode, it moves to Run mode.

10. Set key

- ☑ : To enter into setting value(PS1, PS2) change status and shift digit of setting value(PS1, PS2).
- ☒ : To decrease setting value in setting value change mode, change setting value in function setting mode, move down checked value in function setting check mode.
- ☑ : To increase setting value in setting value change mode, change setting value in function setting mode, move up checked value in function setting check mode. By pressing **MD** key over 1 sec. in Run mode, enters into function setting check mode.

11. BATCH key

- By pressing **BA** key in run mode to enter into BATCH counter indication mode.

12. BATCH output indicator(red LED)

13. BATCH setting value checking and changing indicator (yellow-green LED)

- Lights when checking and changing BATCH setting value.

Programmable Counter/Timer

Input connections

No-voltage input(NPN)

Solid-state input(Standard sensor : NPN output type sensor)

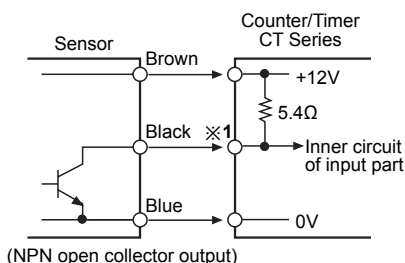
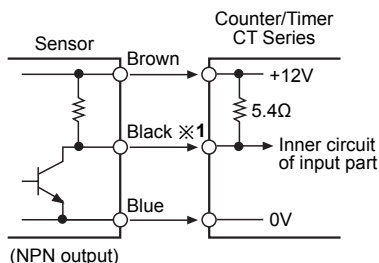

Contact input

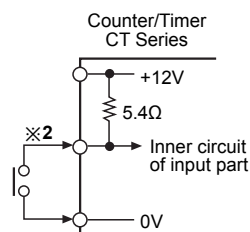

※1: INA, INB/INH, RESET, INHIBIT, BATCH RESET input part

※2: Counting speed: 1 or 30cps setting(Counter)

Voltage input(PNP)

Solid-state input(Standard sensor : PNP output type sensor)

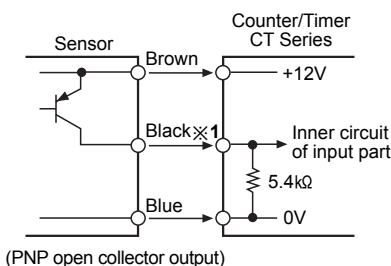
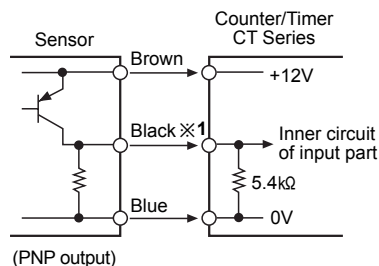

Contact input

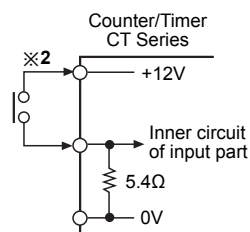

※1: INA, INB/INH, RESET, INHIBIT, BATCH RESET input part

※2: Counting speed: 1 or 30cps setting(Counter)

Input logic Selection[No-voltage input(NPN)/Voltage input(PNP)]

- The power must be cut off.
- Detach the case from the body.
(CTS, CTY Series)
- Select input logic by using input logic switch(SW1) inside Counter/Timer.

Select No-voltage input(NPN)

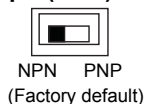

Select voltage input(PNP)

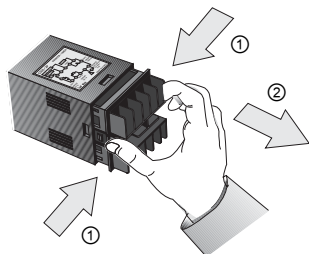

* Case detachment

Squeeze toward ① and pull toward ② as shown in picture.

⚠ Please check if the power is cut off.

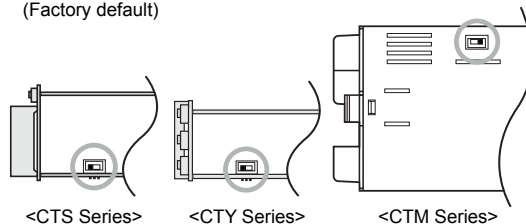

- Push a case in the opposite direction of 2-②.
- Then apply the power to Counter/Timer.

(A)	Photo electric sensor
(B)	Fiber optic sensor
(C)	Door/Area sensor
(D)	Proximity sensor
(E)	Pressure sensor
(F)	Rotary encoder
(G)	Connector/Socket
(H)	Temp. controller
(I)	SSR/ Power controller
(J)	Counter
(K)	Timer
(L)	Panel meter
(M)	Tacho/ Speed/ Pulse meter
(N)	Display unit
(O)	Sensor controller
(P)	Switching mode power supply
(Q)	Stepper motor& Driver&Controller
(R)	Graphic/ Logic panel
(S)	Field network device
(T)	Software
(U)	Other

CT Series

Output connections

Contact output

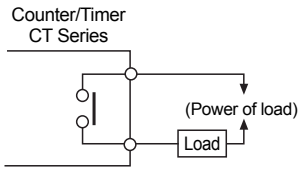

※Use proper load not to exceed the capacity.

Solid-state output

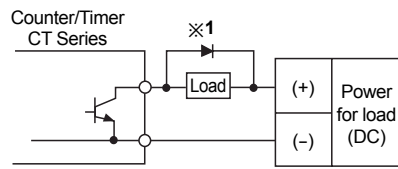

※Use proper load and power for load not to exceed ON/OFF capacity(30VDC Max. 100mA max.) of solid state output.

※Be sure not to apply reverse polarity of power.

※1: When use inductive load(Relay etc), surge absorber (Diode, varistor etc) must be connected between both sides of the load.

Factory default

	Parameter	Factory default
Counter	Input mode (I n)	UP/Down-C (Ud-C)
	Output mode (oUt.n)	F (F)
	CPS (CPS)	30cps (30)
	Indication mode (indicator type)(dSP.n)	TOTAL (t.o.t.R.L)
	OUT2 output time (oUt.2)	Hold (HoLd)
	OUT1 output time (oUt.1)	100ms (00.10)
	Decimal point (dP)	-----
	Min. reset time (rSt)	20ms (20)
	Input logic (Sl G)	NPN (nPN)
	Prescale decimal point (SLdP)	6digit type : -.-.-.-.-, 4digit type : -.-.-
	Prescale value (SL)	6digit type : 1.00000 , 4digit type : 1.000
	Start Point setting (St.r.t)	000000
	Counting memory (dRt.R)	Clear (SLr)
	Lock key (LoCk)	Lock off (LoFF)
Preset value 1 (PS1)	1000 (1000)	
Preset value 2 (PS2)	5000 (5000)	
Timer	Time range (HoUr.Hr nSEc)	6Digit type: 0.001s-999.999s, 4Digit type: 0.001s-9.999s
	Up/Down mode (U-d)	UP (UP)
	Indication mode(Indicator type)(dSP.n)	TOTAL (t.o.t.R.L)
	Memory protection(Indicator type) (dRt.R)	CLEAR (SLr)
	Output mode (oUt.n)	OND (oNd)
	OUT2 output time (oUt.2)	Hold (HoLd)
	OUT1 output time (oUt.1)	100ms (00.10)
	Input logic (Sl G)	NPN (nPN)
	Input signal time (I n.t)	20ms (20)
	Lock key (LoCk)	Lock off (LoFF)
	Preset value 1 (PS1)	1000 (1000)
Preset value 2 (PS2)	5000 (5000)	
Communication	Communication address (Addr)	01 (001)
	Communication speed (bPS)	9600bps (96)
	Communication parity (Pr.t.Y)	NONE (noNE)
	Communication stop bit (StP)	2 (2)
	Response waiting time (rSt.t)	20ms (20)
	Communication writing (Co.n.Y)	Enable (EnR)

Error display

Error display	Errors	Output status	How to return
	Failed in data loading for existing setting values	OFF	Power on again

Programmable Counter/Timer

Operations and functions

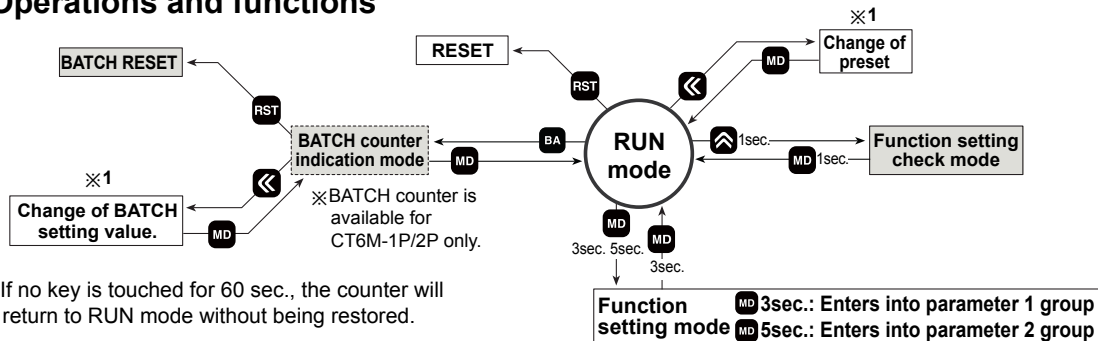

Change of preset(Counter/Timer)

- Even if changing the preset value, input operation and output control will continue. In addition, the preset value could be set to 0 and 0 preset value turns ON. According to output mode, preset value could not be set to 0. (When setting to 0, preset value "0" will flash 3 times.)

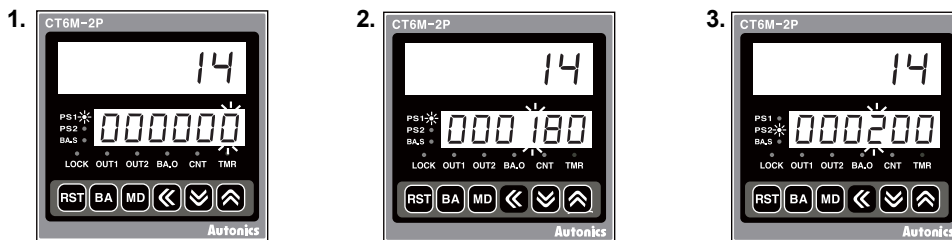

In Run mode, it enters into the preset value setting mode using **←** key. 'PS1' LED lights and first digit of preset value flashes.

The preset value is set to '180' using **←**, **→** and **↵** keys, then press **MD** key to enter into the PS2 setting mode.

The preset value is set to '200' using **←**, **→** and **↵** keys, then press **MD** key to complete PS2 setting and return to Run mode.

- Press **MD** key to save set value after changing the setting value. Then, it moves to next parameter or returns to RUN mode. However, if no key is touched for 60 sec., it will return to RUN mode without being saved.

Function setting check mode

- Setting value of function setting mode can be confirmed using the **↵** and **↵** keys.

Switching display function in preset indicator

- Setting value 1(PS1) and setting value 2(PS2) are displayed each time pressing **MD** key in dual preset model. (In timer, it is available for *ond*, *ond.1*, *ond.2* output mode.)

Reset

- In Run mode or function setting mode, if **RST** key or applying the signal to the RESET terminal on the back side, present value will be initialized and output will maintain off status. When selecting voltage input(PNP), short no. 10 and no. 12 terminals, or when selecting no-voltage input(NPN), short no. 11 and no. 12 terminals to reset.

BATCH Counter(For CT6M-1P□□ /CT6M-2P□□ model only)

In BATCH counter indication mode, 'BATCH counter value' is displayed in count indicator and 'BATCH counter setting value' is displayed in preset indicator.

Change of BATCH setting value

If pressing **BA** key in Run mode, it will enter into BATCH counter indication mode.

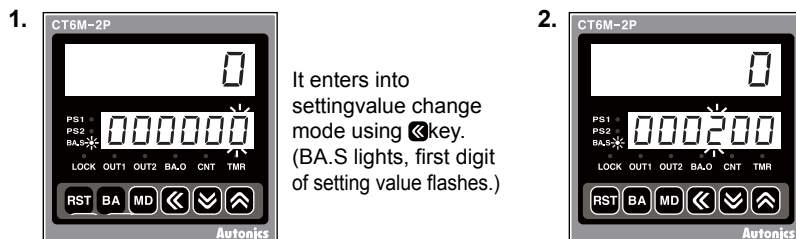

It enters into settingvalue change mode using **←** key. (BA.S lights, first digit of setting value flashes.)

BATCH value is set to '200' using **←**, **→** and **↵** keys, then press **MD** key to complete BATCH setting value and move to BATCH counter indication mode.

(A)	Photo electric sensor
(B)	Fiber optic sensor
(C)	Door/Area sensor
(D)	Proximity sensor
(E)	Pressure sensor
(F)	Rotary encoder
(G)	Connector/Socket
(H)	Temp. controller
(I)	SSR/ Power controller
(J)	Counter
(K)	Timer
(L)	Panel meter
(M)	Tacho/ Speed/ Pulse meter
(N)	Display unit
(O)	Sensor controller
(P)	Switching mode power supply
(Q)	Stepper motor& Driver&Controller
(R)	Graphic/ Logic panel
(S)	Field network device
(T)	Software
(U)	Other

◎ BATCH counter operation

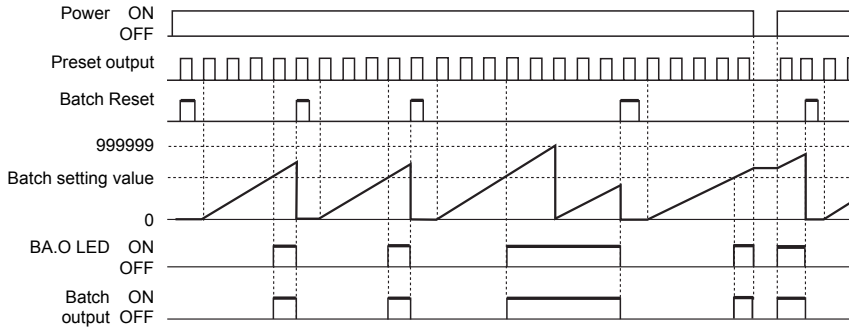

◎ BATCH counting operation

- BATCH counting value is increasing until BATCH reset signal applied. BATCH counting value will be circulated when it is over 999999.
- 1) BATCH counting operation in Counter : Counts the number of reaching setting value of CT6M-1P or reaching dual setting value of CT6M-2P□□
- 2) BATCH counting operation in Timer: Counts the number of reaching setting time.
(In case of "FLK" output mode, count the number of reaching T.off setting time and T.on setting time.)

◎ BATCH output

- If input signal is applied while changing BATCH setting value, counting operation and output control will be performed.
- If BATCH count value equals to BATCH setting value, BATCH output will be ON and maintain ON status until BATCH reset signal is applied.
- When the power is cut off then resupplied in status of BATCH output is ON, BATCH output maintains ON status until BATCH reset signal is applied.

◎ BATCH reset input

- If pressing reset button or applying the signal to BATCH reset terminal on the back side panel, BATCH counting value will be reset. When selecting voltage input(PNP), short no. 10 and no. 14 terminals, or when selecting no-voltage input(NPN), short no. 11 and no. 14 terminals to reset.
- When BATCH reset is applied, BATCH counting value maintains at 0 and BATCH output maintains in the OFF status.

◎ Application of BATCH counter function

● Counter

In case, put 5 products in a box then pack the boxes when they reaches to 200.

- Counter preset setting value="5", BATCH setting value="200"

- When the count value of counter reaches to the preset value "5", the control output(OUT) will be on, and at this time the count value of the BATCH counter will be increased by "1". The control box which is received the control output (OUT) repeatedly controls conveyor to move the full box and to place the next empty box for standby. When the BATCH count value reaches to "200", BATCH output will be ON. Then the control box stops conveyor and provides a control signal for packing.

● Timer

Fills milk into the bottle for 3sec.(setting time) When 500 bottles are filled, BATCH counting finish lamp is turned on. (Setting time : 3sec., BATCH setting value : 500)

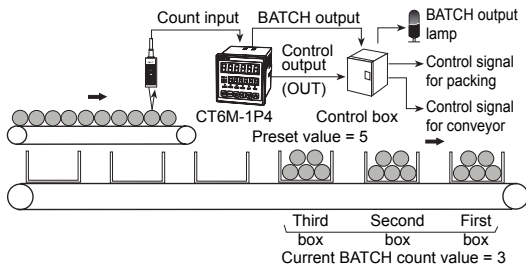
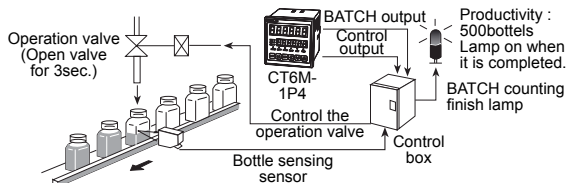

Programmable Counter/Timer

Flow chart for function setting mode

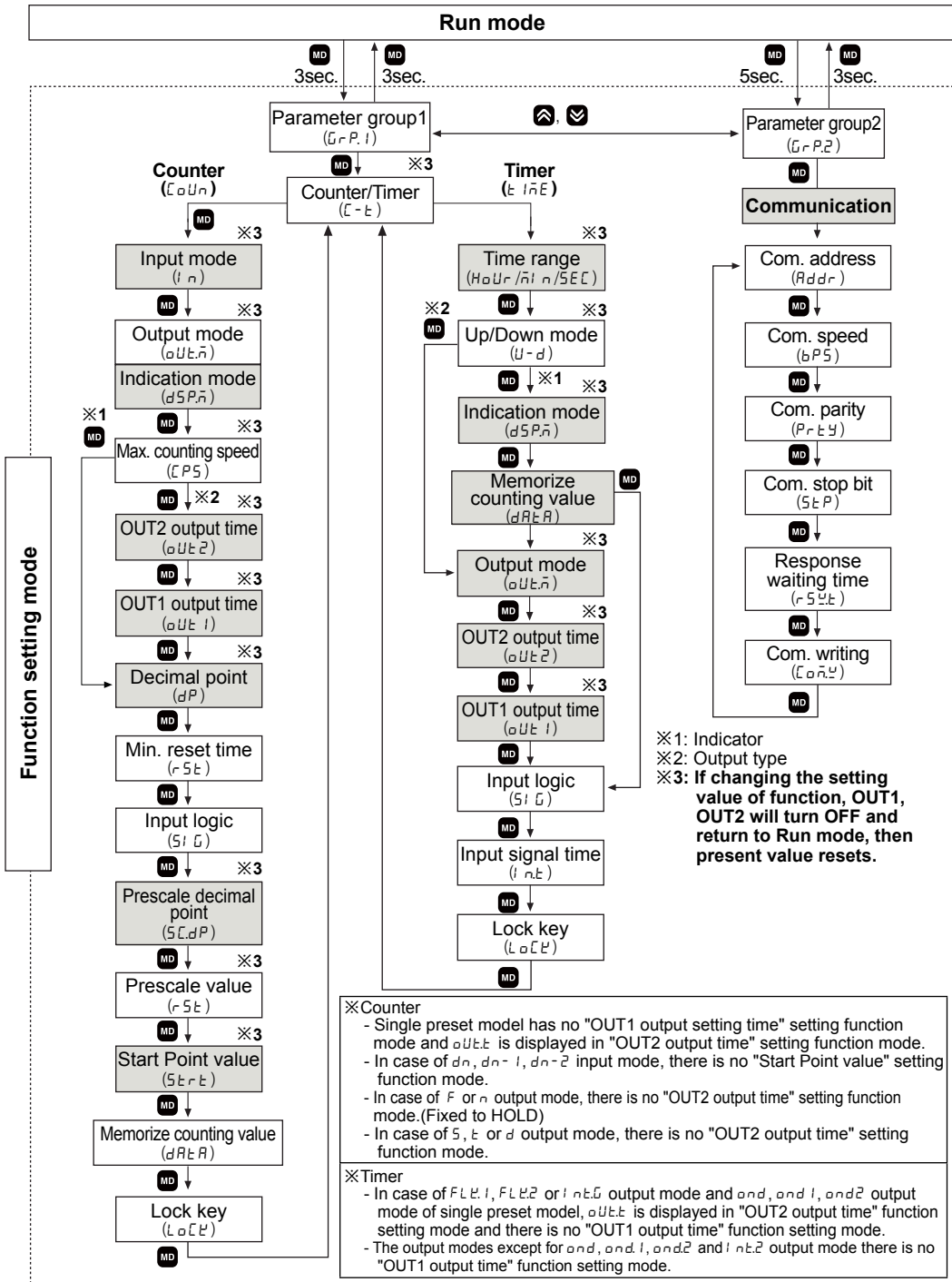

- ※If changing setting value of parameter group1, display value and output will be initialize.
- ※Press MD key over 3sec./5sec. in RUN mode to enter into parameter 1 group/ parameter 2 group.
Press MD key over 3 sec. in function setting mode to return RUN mode.
- ※Input operation and output control can be set in function setting mode.
- ※If changing set value of ※3 marked parameters in function setting mode, OUT1 and OUT2 output will be turned OFF and then the current value is reset.
- ※Parameter 2 group is not available to non-communication models.

(A)	Photo electric sensor
(B)	Fiber optic sensor
(C)	Door/Area sensor
(D)	Proximity sensor
(E)	Pressure sensor
(F)	Rotary encoder
(G)	Connector/ Socket
(H)	Temp. controller
(I)	SSR/ Power controller
(J)	Counter
(K)	Timer
(L)	Panel meter
(M)	Tacho/ Speed/ Pulse meter
(N)	Display unit
(O)	Sensor controller
(P)	Switching mode power supply
(Q)	Stepper motor& Driver&Controller
(R)	Graphic/ Logic panel
(S)	Field network device
(T)	Software
(U)	Other

Parameter setting(Counter)

(**MD** key: To select setting mode, **↔** or **↔** key: To change setting value)

Setting mode	How to set
Counter/Timer C-oU n	C-oU n ↔ t-i n E ※C-o n E: COUNTER t-i n E: TIMER
Input mode i n	U d-C ↔ U P ↔ U P-1 ↔ U P-2 ↔ d n ↔ d n-1 ↔ d n-2 ↔ U d-R ↔ U d-b
Output mode oU t.n	<ul style="list-style-type: none"> • U P, U P-1, U P-2 or d n, d n-1, d n-2 input mode F ↔ n ↔ C ↔ r ↔ y ↔ P ↔ q ↔ A ※In case that output mode is F, n there is no "OUT2 output time" setting mode. (Fixed to HOLD) • U d-R, U d-b, U d-C input mode F ↔ n ↔ C ↔ r ↔ y ↔ P ↔ q ↔ A ↔ 5 ↔ t ↔ d ※If output mode is set to d when max. counting speed is set to 5Kcps, 10Kcps, max. counting speed is automatically set to 30cps. (Factory default setting)
Indication mode dSP.n	<ul style="list-style-type: none"> • In case of the indicator HoL d ↔ t-o t R L ※In case of the indicator, indicate mode selection (dSP.n) is displayed. ※It is added that the function which can set the preset value when selecting HoL d. (Refer to J-22 page 'Counter operation of the indicator'.)
Max. counting speed CP S	30 ↔ 1K ↔ 5K ↔ 10K ↔ 1 ※Counting speed is that of one by one(1:1) duty ratio of INA or INB input signal, and it is applied in INA and INB at the same time. ※In case of setting d in output mode, you can choose 1cps, 30cps, 1Kcps.
OUT2 output time oU t.2	<ul style="list-style-type: none"> Ⓚ : To shift flashing digit position of OUT2 output time value. ↔ : To change OUT2 output time value. ※Set OUT2 one-shot output time. ※Setting range: 0.01 to 99.99 sec. ※It does not appear if F, n output mode is selected.
OUT1 output time oU t.1	<ul style="list-style-type: none"> Ⓚ : To shift flashing digit position of OUT1 output time value. ↔ : To change OUT1 output time value. ※Set OUT1 one-shot setting time ※Time range: 0.01 to 99.99 sec., Hold ※HoL d is displayed by pressing Ⓚ key 4 times.
※1 Decimal point dP	<ul style="list-style-type: none"> • 6digit type • 4digit type ※Setting the decimal point is applied same to counting value and setting value.
Min. reset time r S t	1 ↔ 20 unit: ms ※Set the min. external RESET signal width.
Input logic S i G	n P n: No-Voltage input P n P: Voltage input ※Check input logic value(PNP, NPN).
※1 Prescale decimal point S C d P	<ul style="list-style-type: none"> • 6digit type • 4digit type ※Prescale decimal point position is not set below the decimal point setting digits (dP).
Prescale value S C L	<ul style="list-style-type: none"> Ⓚ : To shift the flashing digit. ↔ : To change the prescale value. ※Setting range of prescale value 6digit type: 0.00001 to 99999.9 4digit type: 0.001 to 999.9 ※Refer to the J-20 page '▣ Prescale function'.
Start Point Value S t r t	<ul style="list-style-type: none"> Ⓚ : To shift the flashing digit. ↔ : To change the Start Point value. ※Setting range of Start Point value (Connected with decimal point setting) 6digit type: 0.00000 to 999999 4digit type: 0.000 to 9999 ※Refer to the J-20 page '▣ Start Point function'.
Memory protection d R t R	C L r ↔ r E C ※C L r: Initializes count value when power is off. ※r E C: Memorizes count value at the moment of power off.
Lock key L o C k	L o F F ↔ L o C.1 L o C.3 ↔ L o C.2 ※L o F F: Cancellation of the lock mode. L o C.1: Locks MD key. L o C.2: Locks Ⓚ , ↔ , ↔ keys. L o C.3: Locks MD , Ⓚ , ↔ , ↔ keys.

※1. Explanation of decimal point and prescale decimal point setting

- Decimal point setting : Set decimal point of the display value on front indicator.

- Prescale decimal point setting : Set prescale decimal point of counting regardless of decimal point of display value on front indicator.

Programmable Counter/Timer

Input operation mode(Counter)

Input mode	Count chart	Operation
<i>UP</i> (UP)		※If INA is counting input, INB is inhibition input. If INB is counting input, INA is inhibition input.
<i>UP-1</i> (Up-1)		※Counts when INA input signal is up. (↑) ※INA: Counting input ※INB: Inhibition input
<i>UP-2</i> (Up-2)		※Counts when INA input signal is down. (↓) ※INA: Counting input ※INB: Inhibition input
<i>dn</i> (Down)		※If INA is counting input, INB is inhibition input. If INB is counting input, INA is inhibition input.
<i>dn-1</i> (Down-1)		※Count when INA input signal is up. (↑) ※INA: Counting input ※INB: Inhibition input
<i>dn-2</i> (Down-2)		※Counts when INA input signal is down. (↓) ※INA: Counting input ※INB: Inhibition input
<i>Up/Down-A</i> (Up/Down-A)		※INA: Counting input INB: Counting command input ※When INB is L, counting Up. When INB is H, counting Down.

(A) Photo electric sensor

(B) Fiber optic sensor

(C) Door/Area sensor

(D) Proximity sensor

(E) Pressure sensor

(F) Rotary encoder

(G) Connector/Socket

(H) Temp. controller

(I) SSR/Power controller

(J) Counter

(K) Timer

(L) Panel meter

(M) Tacho/Speed/Pulse meter

(N) Display unit

(O) Sensor controller

(P) Switching mode power supply

(Q) Stepper motor& Driver&Controller

(R) Graphic/Logic panel

(S) Field network device

(T) Software

(U) Other

Input operation mode(Counter)

Input mode	Count chart	Operation
$Ud-b$ (Up/Down-B)		※INA: Up counting input INB: Down counting input ※When both INA and INB are applied to L->H, it will remain previous counting value.
$Ud-C$ (Up/Down-C)		※When use A,B phase of encoder with connecting to INA, INB, please set counter input mode(i_n) as phase different input($Ud-C$).

※ⓐ signal width should be over min. signal width and ⓑ signal width should be over a half min. signal width. If not, ± 1 will occur.

※The meaning of "H" and "L"

	Voltage input (NPN)	No-Voltage input (PNP)
H	5-30VDC	Short circuit
L	0-2VDC	Open

※Min. signal width by counting speed

Counting speed	Min. signal width
1cps	500ms
30cps	16.7ms
1kcps	0.5ms
5kcps	0.1ms
10kcps	0.05ms

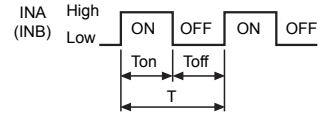

※Ton, Toff : Min. signal width

Prescale function(Counter)

This function is to set and indicate calculated unit for actual length, liquid measure, position etc. It is called "Prescale value" for measured length, measured liquid, measured position, etc per 1 pulse.

For example, P is the number of pulses per 1 revolution of a rotary encoder and L is the desired length to be measured.

Prescale value is [the desired length (L)]/[the number of pulses (P) per 1 revolution of the rotary encoder].

It is the length per 1 pulse of a rotary encoder.

Ex) Control length by the counter and the rotary encoder

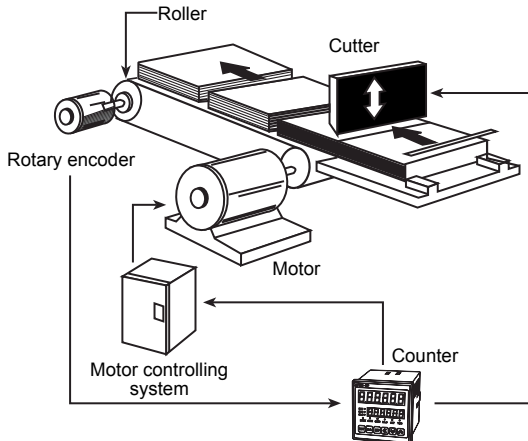

[In case of 22mm diameter(D) of roller connected with the encoder of 1,000 pulse]

$$\begin{aligned}
 \bullet \text{ Prescale value} &= \frac{\pi \times \text{Diameter of the roller}(D)}{\text{The number of pulses per 1 revolution of the encoder}} \\
 &= \frac{3.1416 \times 22}{1000} \\
 &= 0.069\text{mm/pulse}
 \end{aligned}$$

To control conveyor position in 0.1mm, set the decimal point to tenth place(- - - - -) in decimal point setting mode(dP) and set the prescale decimal point to thousandth place(- - - - -) in prescale decimal point setting mode($5CLP$) Then set prescale value "0.069" in prescale setting mode ($5CL$).

Start point function(Counter)

This function is that start point value works as initial value when on counting mode.

- In case of d_n , d_n-1 or d_n-2 in timer input mode, it is not available.
- When reset is applied, the present value is initialized to start point.
- After count up in CL , r , P , q After count up in

Programmable Counter/Timer

■ Output operation mode(Counter)

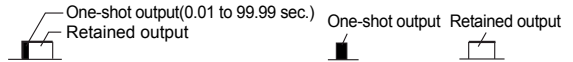

Output mode	Input mode	Down, Down-1, 2	Up/Down A, B, C	Operation
F (F)	RESET 999999 PRESET2 PRESET1 0			<ul style="list-style-type: none"> After count-up, counting display value increases or decreases until reset signal is applied and retained output is maintained.
N (N)	RESET 999999 PRESET2 PRESET1 0			<ul style="list-style-type: none"> After count-up, counting display value and retained output are maintained until reset signal is applied.
C (C)	RESET 999999 PRESET2 PRESET1 0			<ul style="list-style-type: none"> When count-up, counting display value will be reset and count simultaneously. OUT1 retained output will be off after OUT2 one-shot time. The one-shot output time of OUT1 one-shot output time is operated regardless of OUT2 output.
R (R)	RESET 999999 PRESET2 PRESET1 0			<ul style="list-style-type: none"> After OUT2 one-shot time, counting display value will be reset and count simultaneously. OUT1 retained output will be off after OUT2 one-shot time. OUT1 one-shot output time is operated regardless of OUT2 output.
K (K)	RESET 999999 PRESET2 PRESET1 0			<ul style="list-style-type: none"> After count-up, counting display value increases or decreases until RESET input is applied. OUT1 retained output is off after OUT2 one-shot time. OUT1 one-shot output time is operated regardless of OUT2 output.
P (P)	RESET 999999 PRESET2 PRESET1 0			<ul style="list-style-type: none"> After count-up, counting display value is maintained while OUT2 output is on. Counting value is internally reset and counts simultaneously. When OUT2 output is off, displays counting value while OUT2 is ON, and it increases or decreases. OUT1 retained output is off after OUT2 one-shot time. OUT1 one-shot output time is operated regardless of OUT2 output.
Q (Q)	RESET 999999 PRESET2 PRESET1 0			<ul style="list-style-type: none"> After count-up, counting display value increases or decreases during OUT2 one-shot time. OUT1 retained output is off after OUT2 one-shot time. OUT1 one-shot output time is operated regardless of OUT2 output.
A (A)	RESET 999999 PRESET2 PRESET1 0			<ul style="list-style-type: none"> After count-up, counting display value and OUT1 retained output are maintained until RESET input is applied. OUT1 one-shot output time is operated regardless of OUT2 output.

※The single preset type output(OUT) is operated as OUT2 of dual preset type.
 ※OUT1 output could be set to 0 in all modes and 0 value output turns ON.
 ※OUT2 output could not set to 0 in C(ℓ), R(-), P(P) or Q(Q) output mode.

- (A) Photo electric sensor
- (B) Fiber optic sensor
- (C) Door/Area sensor
- (D) Proximity sensor
- (E) Pressure sensor
- (F) Rotary encoder
- (G) Connector/Socket
- (H) Temp. controller
- (I) SSR/Power controller
- (J) Counter
- (K) Timer
- (L) Panel meter
- (M) Tacho/Speed/Pulse meter
- (N) Display unit
- (O) Sensor controller
- (P) Switching mode power supply
- (Q) Stepper motor& Driver&Controller
- (R) Graphic/Logic panel
- (S) Field network device
- (T) Software
- (U) Other

Output operation mode(Counter)

Output mode	Up/Down - A, B, C	Operation
5 (S)		※OUT1 and OUT2 keeps ON status in following condition: Counting display value \geq PRESET1 Counting display value \geq PRESET2
E (T)		※OUT1 output is off: Counting display value \geq PRESET1 ※OUT2 keeps ON status in following condition: Counting display value \geq PRESET2
d (D)		※When counting display value is equal to setting value(PRESET1, PRESET2) only, OUT1 or OUT2 output keeps ON status. ※When setting 1kcps for counting speed, solid state contact output should be used.

※The single preset type output(OUT) is operated as OUT2 of dual preset type.

※The dual preset model OUT1 output is operated as one-shot or retained output.(except S, E, d mode)

※OUT1 output could be set to 0 in all modes and 0 value output turns ON.

※OUT2 output could not set to 0 in C(L), R(r), P(P) or Q(Q) output mode.

Counter operation of the indicator(CT6S-I, CT6Y-I, CT6M-I)

Indicate mode (d5P.n)	Count chart		Operation
	In case of input mode is Up (Up, Up-1, Up-2)	In case of input mode is Down (Down, Down-1, Down-2)	
TOTAL (TOTAL)			Count value increases or decreases until RESET input is applied. When reaching max. count value or min. count value, it will be reset and count simultaneously.
HOLD (HOLD)			Count value increases or decreases until RESET input is applied, count value indicator flashes when reaching preset value(Up count) or 0(Down count).

• In case of the input mode is Command input (Ud-R), Individual input(Ud-b), Phase difference input(Ud-L).

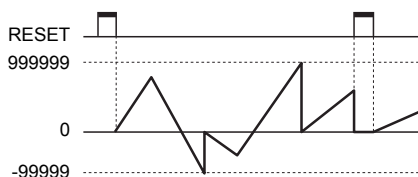

※In case of UP/DOWN (Ud-R, Ud-b, Ud-L) input mode, indication mode (d5P.n) of the configuration is not displayed.

Programmable Counter/Timer

Parameter setting(Timer)

(**MD** key: To select setting mode) or (**↔** key: To change setting value)

Setting mode	How to set
Counter/Timer C- \bar{t}	$C_{oU\bar{n}} \leftrightarrow t\bar{i}\bar{n}E$ <p style="text-align: center;">※$C_{oU\bar{n}}$: COUNTER $t\bar{i}\bar{n}E$: TIMER</p>
Timer range $HoUr/\bar{n}i\bar{n}/SEC$	<p>● 6digit type</p> <p>● 4digit type</p>
UP/DOWN mode U-d	$UP \leftrightarrow d\bar{n}$ <p>※UP: Time proceeds from 0 to the setting value. ※$d\bar{n}$: Time proceeds from the setting value to 0.</p>
Indication mode dSP,\bar{n}	$t\bar{o}t\bar{A}L \leftrightarrow HoLd \leftrightarrow o\bar{n}t.d$ <p>※Used for the indicator only. ※ It is added that the feature which set the setting time when selecting $HoLd$ or $o\bar{n}t.d$ (Refer to J-28 page "Timer operation for the indicator").</p>
Memory protection $d\bar{A}t\bar{A}$	$C\bar{L}r \leftrightarrow r\bar{E}C$ <p>※Used for the indicator only. ※$C\bar{L}r$: Initializes time value when power is off. ※$r\bar{E}C$: Memorizes time value at the moment of power off.</p>
Output mode oUt,\bar{n}	$o\bar{n}d \leftrightarrow o\bar{n}d.1 \leftrightarrow o\bar{n}d.2 \leftrightarrow FL\bar{E} \leftrightarrow FL\bar{E}.1 \leftrightarrow FL\bar{E}.2 \leftrightarrow I\bar{n}t$ $I\bar{n}t\bar{G} \leftrightarrow nFd.1 \leftrightarrow nFd \leftrightarrow oFd \leftrightarrow I\bar{n}t.2 \leftrightarrow I\bar{n}t.1$
OUT2 output time $oUt.2$	<p>⏏ key: To shift flashing digit position of OUT2 output time value. ⏏ key: To change OUT2 output time value. ※Set OUT2 one-shot output time. ※Setting range: 0.01 to 99.99sec. ※$HoLd$ is displayed by pressing ⏏ key 4 times.</p>
OUT1 output time $oUt.1$	<p>⏏ key: To shift flashing digit position of OUT1 output time value. ⏏ key: To change OUT1 output time value. ※Set OUT1 one-shot output time. ※Setting range: 0.01 to 99.99sec., Hold ※$HoLd$ is displayed by pressing ⏏ key 4 times.</p>
Input logic SIG	<p>※nPN: No-Voltage input ※PNP: Voltage input</p> <p>※Check input logic value(PNP, NPN).</p>
Input signal time $I\bar{n}t$	$I \leftrightarrow 20$ [unit: ms] <p>※CTS/CTY: Set min. external INA, INH, RESET signal width. ※CTM: Set min. external INA, RESET, INHIBIT, BATCH RESET signal width.</p>
Lock key $LoCk$	$LoFF \leftrightarrow LoC.1$ $LoC.3 \leftrightarrow LoC.2$ <p>※$LoFF$: Cancellation of the lock mode $LoC.1$: Locks SET key. $LoC.2$: Locks ⏏, ↔, ⏏ keys. $LoC.3$: Locks RESET, ⏏, ↔, ⏏ keys.</p>

- (A) Photo electric sensor
- (B) Fiber optic sensor
- (C) Door/Area sensor
- (D) Proximity sensor
- (E) Pressure sensor
- (F) Rotary encoder
- (G) Connector/Socket
- (H) Temp. controller
- (I) SSR/ Power controller
- (J) Counter
- (K) Timer
- (L) Panel meter
- (M) Tacho/ Speed/ Pulse meter
- (N) Display unit
- (O) Sensor controller
- (P) Switching mode power supply
- (Q) Stepper motor& Driver&Controller
- (R) Graphic/ Logic panel
- (S) Field network device
- (T) Software
- (U) Other

Output operation mode(Timer)

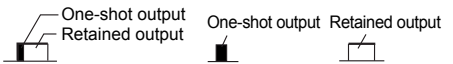

Output mode	Input mode	Operation
OND (OND)	Signal On Delay(Power Reset)	<ol style="list-style-type: none"> Time starts when INA signal turns on. When INA signal turns off, time resets. When INA signal is on: Power ON Time Start is operated Power OFF Time Start is operated Control output operates as retained or one-shot output. <p>T1: Setting time1 T2: Setting time2</p>
	Signal On Delay 1(Power Reset)	<ol style="list-style-type: none"> Time starts when INA signal turns on, if INA signal is applied repeatedly, only initial signal is recognized. When INA signal is on: Power ON Time Start is operated Power OFF Time Start is operated Control output operates as retained or one-shot output. Only first INA input signal is valid in case INA input signal is repeatedly applied. <p>T1: Setting time1 T2: Setting time2</p>
OND.1 (OND.1)	Power On Delay(Power Hold)	<ol style="list-style-type: none"> Time starts when power turns on. (There is no INA function.) Time resets when reset turns on. Time starts when reset turns off. Control output operates as retained or one-shot output. It memorizes display value at the moment of power off. <p>T1: Setting time1 T2: Setting time2</p>
	Flicker(Power Reset)	<ol style="list-style-type: none"> Time starts when INA signal turns on. When INA signal is on: Power ON Time Start is operated Power OFF Time Start is operated Control output operates as retained output, output turns off for the T.off time and turns on for the T.on time repeatedly. Ta+Tb = T.off setting time The T.on time and T.off time must be set individually. In case of using the contact output, min. setting time must be set over 100ms. <p>T.off T.on Ta Tb T.off T.on T.off T.on T.off</p>

※Power Reset: There is no memory protection.(Initializes the display value when power is off)
 Power Hold: There is memory protection.(Memorizes the display value at the moment of power off, indicates the memorized display value when power is resupplied.)

Programmable Counter/Timer

Output operation mode(Timer)



Output mode	Input mode	Operation
FLK.1 (FLK.1)	Flicker 1(Power Reset)	<ol style="list-style-type: none"> 1) Time starts when INA signal turns on. 2) When INA signal is on: Power ON Time Start is operated 3) Control output operates as retained output. 4) In case of using the contact output, min. setting time must be set over 00ms.
	Hold output	
	One-Shot output	<ol style="list-style-type: none"> 1) Time starts when INA signal turns on. 2) When INA signal is on: Power ON Time Start is operated 3) Control output operates as one-shot output. 4) In case of using the contact output, min. setting time must be set over 100ms.
	One-Shot output	
FLK.2 (FLK.2)	Flicker 2(Power Hold)	<ol style="list-style-type: none"> 1) Time starts when INA signal turns ON and the display value at the moment when power is off is memorized. 2) When INA signal is on: Power ON Time Start is operated 3) Control output operates as retained output. 4) Control output will be reversed when it reaches to setting time.(At the initial start, OUT2 control output is OFF). 5) In case of using the contact output, min. setting time must be set over 100ms.
	Hold output	
	One-Shot output	<ol style="list-style-type: none"> 1) Time starts when INA signal turns ON and the display value at the moment when power is off is memorized. 2) When INA signal is on: Power ON Time Start is operated 3) Control output operates as one-shot output. 4) In case of using the contact output, min. setting time must be set over 100ms.
	One-Shot output	

※Power Reset: There is no memory protection.(Initializes the display value when power is off)

Power Hold: There is memory protection.(Memorizes the display value at the moment of power off, indicates the memorized display value when power is resupplied.)

(A) Photo electric sensor

(B) Fiber optic sensor

(C) Door/Area sensor

(D) Proximity sensor

(E) Pressure sensor

(F) Rotary encoder

(G) Connector/Socket

(H) Temp. controller

(I) SSR/Power controller

(J) Counter

(K) Timer

(L) Panel meter

(M) Tacho/Speed/Pulse meter

(N) Display unit

(O) Sensor controller

(P) Switching mode power supply

(Q) Stepper motor& Driver&Controller

(R) Graphic/Logic panel

(S) Field network device

(T) Software

(U) Other

Output operation mode(Timer)

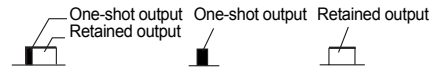

Output mode	Input mode	Operation
INT (INT)	Interval (Power Reset)	1) Control output turns ON and time starts when INA signal turns ON. 2) When INA signal is on: Power ON Time Start is operated Power OFF Time Start is operated 3) When it reaches setting time, indication value and control output are reset automatically. 4) Control output is ON when time is progressing.
		<p>T:Setting time</p>
INT.1 (INT.1)	Interval 1(Power Reset)	1) Control output turns ON and time starts when INA signal turns ON. 2) When INA signal is on: Power ON Time Start is operated Power OFF Time Start is operated 3) When it reaches setting time, indication value and control output are reset automatically. 4) Control output is ON when time is progressing. 5) INA input is ignored while time is progressing.
		<p>T:Setting time</p>
INT.2 (INT.2)	Interval 2(Power Reset)	1) Time starts when INA input is ON and resets when INA input is OFF. 2) INA input is ON, OUT1 output is ON during T1 or t1. 3) When it reaches setting time1, display value resets and OUT2 output is ON during T2 or t2 output time. ※ Output turns OFF when reaching the setting time even if one-shot time is longer than setting time.
		<p>T1: Setting time1 T2: Setting time2 t1: One-shot1 t2: One-shot2</p> <p>(Single preset model has no INT.2 mode)</p>

※Power Reset: There is no memory protection.(Initializes the display value when power is off)

Power Hold: There is memory protection.(Memorizes the display value at the moment of power off, indicates the memorized display value when power is resupplied.)

Programmable Counter/Timer

Output operation mode(Timer)



Output mode	Input mode	Operation
OFd (OFD)	Signal Off Delay1(Power Reset)	<p>1) If INA is ON, control output remains ON. (except when power is off and reset is on)</p> <p>2) When INA signal is OFF, time processes.</p> <p>3) When it reaches setting time, indication value and control output are reset automatically.</p>
		<p>T: Setting time</p>
nFd (NFD)	On-Off Delay (Power Reset)	<p>1) When INA input is ON, output is ON and time is progressing, then output is OFF after On_Delay time.</p> <p>2) When INA input is OFF, output is ON and time is progressing, then output is OFF after Off_Delay time.</p> <p>3) If INA input is OFF within On_Delay time, step 2 starts again.</p> <p>4) If INA input is ON within Off_Delay time, step 1 starts again.</p>
		<p>T1: On_Delay T2: Off_Delay</p>
nFd.1 (NFD.1)	On-Off Delay1 (Power Hold)	<p>1) When INA input turns ON, time progresses and output turns ON after On_Delay time.</p> <p>2) When INA input turns OFF, time progresses and output turns OFF after Off_Delay time.</p> <p>3) If INA input turns OFF within On_Delay time, output will turn ON and step2 operate.</p> <p>4) If INA input turns ON within Off_Delay time, output will turn OFF and step1 operate.</p>
		<p>T1: On_Delay T2: Off_Delay</p>
INTG (INTG)	Integration Time(Power Reset)	<p>1) Time is progressing while INA input is ON.</p> <p>2) Time progress stops while INA input is OFF.</p> <p>3) When it reaches the setting time, output is ON.</p>

- (A) Photo electric sensor
- (B) Fiber optic sensor
- (C) Door/Area sensor
- (D) Proximity sensor
- (E) Pressure sensor
- (F) Rotary encoder
- (G) Connector/Socket
- (H) Temp. controller
- (I) SSR/Power controller
- (J) Counter
- (K) Timer
- (L) Panel meter
- (M) Tacho/Speed/Pulse meter
- (N) Display unit
- (O) Sensor controller
- (P) Switching mode power supply
- (Q) Stepper motor& Driver&Controller
- (R) Graphic/Logic panel
- (S) Field network device
- (T) Software
- (U) Other

※Power Reset: There is no memory protection.(Initializes the display value and the output status when re-supplying the power.)
 Power Hold: There is memory protection.(It memorizes the status of power off. When re-supplying the power, it returns the memorized display value and the output status.)

■ Timer operation of the indicator(CT6S-I, CT6Y-I, CT6M-I)

TOTAL (TOTAL)	<p>When memory protection setting is OFF</p>	<ol style="list-style-type: none"> 1) Time starts when INA input is ON. 2) Setting value is initialized when Reset input is ON. 3) Time progress stops when INHIBIT input is ON. 4) Resets when power is OFF.
	<p>When memory protection setting is ON</p>	<ol style="list-style-type: none"> 1) Time starts when INA input is ON. 2) Setting value is initialized when Reset input is ON. 3) Time progress stops while INHIBIT input is ON. 4) Display value at the moment of power OFF is memorized.
Hold (HOLD)	<p>When memory protection setting is OFF</p>	<ol style="list-style-type: none"> 1) Time progresses when INA input is ON. 2) Time progress stops while INA input is OFF. 3) When time reaches setting time, display value will stop and flash. 4) When reset input is applied, display value is initialized. 5) Resets when power is OFF.
	<p>When memory protection setting is ON</p>	<ol style="list-style-type: none"> 1) Time progresses when INA input is ON. 2) Time progress stops while INA input is OFF. 3) When time reaches setting time, display value will stop and flash. 4) When reset input is applied, display value is initialized. 5) Display value the moment when power is OFF is memorized.
On t.d (On Time Display)	<p>When memory protection setting is OFF</p>	<p>※ON time indicate mode of INA input</p> <ol style="list-style-type: none"> 1) Time reset start operates when INA input turns ON. 2) Time progress stops while INA input is OFF. 3) When time progress stops and power is off, the display value is initialized. 4) If progress time is greater than setting time when INA input turns off, display value flashes and operation stops until reset signal is applied.
	<p>When memory protection setting is ON</p>	<p>※ON time indicate mode of INA input</p> <ol style="list-style-type: none"> 1) Time reset start operates when INA input turns ON. 2) Time progress stops while INA input is OFF. 3) When time progress stops and power is off, the display value is memorized. 4) If progress time is greater than setting time when INA input turns off, display value flashes and operation stops until reset signal is applied.

Programmable Counter/Timer

■ Timer '0' time setting

○ Available output operation mode to set '0' time setting

$ond, ond.1, ond.2, nfd, nfd.1$

○ Operation according to output mode(at 0 time setting)

1) OND(Signal ON Delay) mode [ond]

● Setting time1 is set to 0

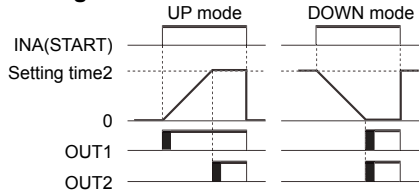

● Setting time2 is set to 0

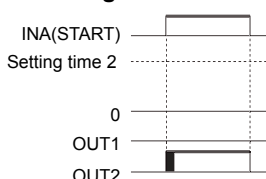

2) OND.1(Signal ON Delay 1) mode [$ond.1$]

● Setting time1 is set to 0

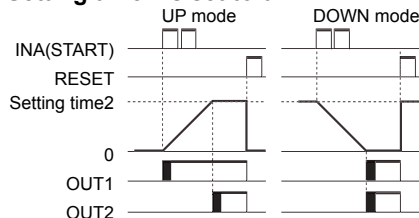

● Setting time2 is set to 0



3) OND.2(Power ON Delay2) mode [$ond.2$]

● Setting time1 is set to 0

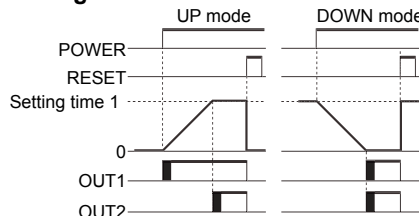

● Setting time2 is set to 0

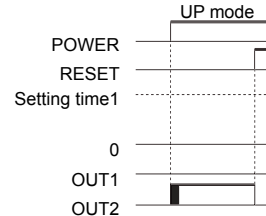

4) NFD(ON-OFF Delay) mode [nfd]

● OFF_Delay setting time is set to 0

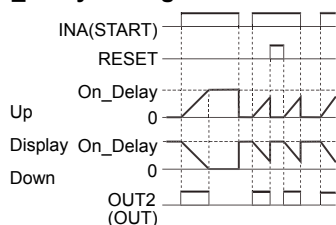

● ON_Delay setting time is set to 0

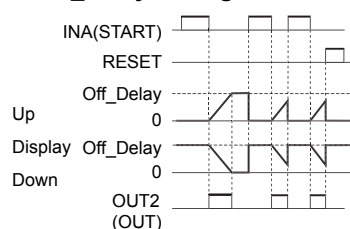

5) NFD.1(ON-OFF Delay1) mode [$nfd.1$]

● OFF_Delay setting time is set to 0

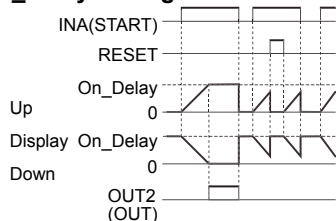

● ON_Delay setting time is set to 0

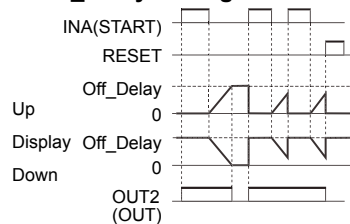

○ Setting value1(PS1) is higher than Setting value2(PS2)

OND(ond), OND.1($ond.1$) or OND.2($ond.2$) output mode

- UP mode: When the timer setting value1 is greater than the setting value 2, OUT1 output does not turn ON.
- DOWN mode: When the timer setting value1 is greater than the setting value 2, OUT1 output does not turn ON.
If the setting value 1 is same as the setting value2 and START signal is applied, OUT1 output turns ON immediately.

(A)	Photo electric sensor
(B)	Fiber optic sensor
(C)	Door/Area sensor
(D)	Proximity sensor
(E)	Pressure sensor
(F)	Rotary encoder
(G)	Connector/Socket
(H)	Temp. controller
(I)	SSR/ Power controller
(J)	Counter
(K)	Timer
(L)	Panel meter
(M)	Tacho/ Speed/ Pulse meter
(N)	Display unit
(O)	Sensor controller
(P)	Switching mode power supply
(Q)	Stepper motor& Driver&Controller
(R)	Graphic/ Logic panel
(S)	Field network device
(T)	Software
(U)	Other

Programmable Counter/Timer

Communication command and block

The format of query and response

1) Read Coil Status(Func 01 H), Read Input Status(Func 02 H)

• Query(Master)

Slave Address	Function	Starting Address		No. of Points		Error Check (CRC 16)	
		High	Low	High	Low	Low	High
1Byte	1Byte	1Byte	1Byte	1Byte	1Byte	1Byte	1Byte

CRC 16

• Response(Slave)

Slave Address	Function	Byte Count	Data			Error Check (CRC 16)	
			Low	High	Low	High	
1Byte	1Byte	1Byte	1Byte	1Byte	1Byte	1Byte	1Byte

CRC 16

2) Read Holding Registers(Func 03 H), Read Input Registers(Func 04 H)

• Query(Master)

Slave Address	Function	Starting Address		No. of Points		Error Check (CRC 16)	
		High	Low	High	Low	Low	High
1Byte	1Byte	1Byte	1Byte	1Byte	1Byte	1Byte	1Byte

CRC 16

• Response(Slave)

Slave Address	Function	Byte Count	Data			Error Check (CRC 16)	
			High	Low	High	Low	Low
1Byte	1Byte	1Byte	1Byte	1Byte	1Byte	1Byte	1Byte

CRC 16

3) Force Single Coil(Func 05 H)

• Query(Master)

Slave Address	Function	Coil Address		Force Data		Error Check (CRC 16)	
		High	Low	High	Low	Low	High
1Byte	1Byte	1Byte	1Byte	1Byte	1Byte	1Byte	1Byte

CRC 16

• Response(Slave)

Slave Address	Function	Coil Address		Force Data		Error Check (CRC 16)	
		High	Low	High	Low	Low	High
1Byte	1Byte	1Byte	1Byte	1Byte	1Byte	1Byte	1Byte

CRC 16

4) Preset Single Register(Func 06 H)

• Query(Master)

Slave Address	Function	Register Address		Preset Data		Error Check (CRC 16)	
		High	Low	High	Low	Low	High
1Byte	1Byte	1Byte	1Byte	1Byte	1Byte	1Byte	1Byte

CRC 16

• Response(Slave)

Slave Address	Function	Register Address		Preset Data		Error Check (CRC 16)	
		High	Low	High	Low	Low	High
1Byte	1Byte	1Byte	1Byte	1Byte	1Byte	1Byte	1Byte

CRC 16

5) Preset Multiple Registers(Func 10 H)

• Query(Master)

Slave Address	Function	Starting Address		No. of Register		Byte Count	Data		Data		Error Check (CRC 16)	
		High	Low	High	Low		High	Low	High	Low	High	
1Byte	1Byte	1Byte	1Byte	1Byte	1Byte	1Byte	1Byte	1Byte	1Byte	1Byte	1Byte	1Byte

CRC 16

• Response(Slave)

Slave Address	Function	Starting Address		No. of Register		Error Check (CRC 16)	
		High	Low	High	Low	Low	High
1Byte	1Byte	1Byte	1Byte	1Byte	1Byte	1Byte	1Byte

CRC 16

6) Application

Read Coil Status(Func 01 H)

Master reads OUT2 00002(0001H) to 00003(0002H),
OUT1 output status(ON : 1, OFF : 0) from the
Slave(Address 01).

• Query(Master)

Slave Address	Function	Starting Address		No. of Points		Error Check (CRC 16)	
		High	Low	High	Low	Low	High
01 H	01 H	00 H	01 H	00 H	02 H	EC H	0B H

On slave side OUT2 00003(0002H) : OFF,
OUT1 00002(0001H) : ON

• Response(Slave)

Slave Address	Function	Byte Count	Data (00003 to 00001)		Error Check (CRC 16)	
			Low	High	Low	High
01 H	01 H	01 H	02 H	D0 H	49 H	

Read Input Register (Func 04 H)Master reads preset value
21004(03EBH) to 21005(03ECH) of counter/timer, Slave
(Address 15).

• Query(Master)

Slave Address	Function	Starting Address		No. of Points		Error Check (CRC 16)	
		High	Low	High	Low	Low	High
0F H	04 H	03 H	EB H	00 H	02 H	00 H	95 H

In case that the present value is 123456(0001 E240 H) in
slave side, 31004(03EBH): E240 H, 31005(03ECH): 0001H

• Response(Slave)

Slave Address	Function	Byte Count	Data		Data		Error Check (CRC 16)	
			High	Low	High	Low	Low	High
0F H	04 H	04 H	E2 H	40 H	00 H	01 H	E2 H	28 H

(A) Photo electric sensor

(B) Fiber optic sensor

(C) Door/Area sensor

(D) Proximity sensor

(E) Pressure sensor

(F) Rotary encoder

(G) Connector/Socket

(H) Temp. controller

(I) SSR/ Power controller

(J) Counter

(K) Timer

(L) Panel meter

(M) Tacho/ Speed/ Pulse meter

(N) Display unit

(O) Sensor controller

(P) Switching mode power supply

(Q) Stepper motor& Driver&Controller

(R) Graphic/ Logic panel

(S) Field network device

(T) Software

(U) Other

◎ Modbus Mapping Table

1) Reset/Output

No(Address)	Func	Explanation	Setting range	Notice
00001(0000)	01/05	Reset	0:OFF 1:ON	
00002(0001)	01	OUT2 output	0:OFF 1:ON	
00003(0002)	01	OUT1 output	0:OFF 1:ON	
00004(0003)	01	BATCH output	0:OFF 1:ON	For BATCH output model
00005(0004)	01/05	BATCH resets	0:OFF 1:ON	For BATCH output model

2) Terminal input status

No(Address)	Func	Explanation	Setting range	Notice
10001(0000)	02	INA input status	0:OFF 1:ON	Terminal input status
10002(0001)	02	INB input status	0:OFF 1:ON	Terminal input status
10003(0002)	02	INHIBIT input status	0:OFF 1:ON	Terminal input status
10004(0003)	02	RESET input status	0:OFF 1:ON	Terminal input status
10005(0004)	02	BATCH RESET input status	0:OFF 1:ON	Terminal input status

3) Product Information

No(Address)	Func	Explanation	Notice
30001~30100	04	Reserved	—
30101(0064)	04	Product number H	Model ID
30102(0065)	04	Product number L	
30103(0066)	04	Hardware version	—
30104(0067)	04	Software version	—
30105(0068)	04	Model no. 1	"CT"
30106(0069)	04	Model no. 2	"6M"
30107(006A)	04	Model no. 3	"2"
30108(006B)	04	Model no. 4	"PT"
30109(006C)	04	Reserved	—
30110(006D)	04	Reserved	—
30111(006E)	04	Reserved	—
30112(006F)	04	Reserved	—
30113(0070)	04	Reserved	—
30114(0071)	04	Reserved	—
30115(0072)	04	Reserved	—
30116(0073)	04	Reserved	—
30117(0074)	04	Reserved	—
30118(0075)	04	Coil Status Start Address	0000
30119(0076)	04	Coil Status Quantity	—
30120(0077)	04	Input Status Start Address	0000
30121(0078)	04	Input Status Quantity	—
30122(0079)	04	Holding Register Start Address	0000
30123(007A)	04	Holding Register Quantity	—
30124(007B)	04	Input Register Start Address	0064
30125(007C)	04	Input Register Quantity	—

4) Monitoring data

No(Address)	Func	Explanation	Setting range	Notice
31001(03E8)	04	BA.O LED display status	0:OFF 1:ON	Bit 5
		OUT2 LED display status	0:OFF 1:ON	Bit 6
		OUT1 LED display status	0:OFF 1:ON	Bit 7
		BA.S LED display status	0:OFF 1:ON	Bit 10
		LOCK LED display status	0:OFF 1:ON	Bit 11
		PS2 LED display status	0:OFF 1:ON	Bit 12
		PS1 LED display status	0:OFF 1:ON	Bit 13
		TMR LED display status CNT LED display status	0:OFF 1:ON	Bit 14 Bit 15
31002(03E9)	04	Present value of BATCH counter	0 to 999999	For BATCH output model
31003(03EA)				
31004(03EB)	04	Present value of counter/timer	Counter 6digit type: -99999 to 999999 4digit type: -999 to 9999 Timer: Within time setting range	Use counter and timer in common
31005(03EC)				
31006(03ED)	04	Display unit	Counter: decimal point of display value Timer: Time range	Counter: 40058 Data Timer: 40102 Data
31007(03EE)	04	PS(2) setting value	Counter 6digit type: -99999 to 999999 4digit type: -999 to 9999 Timer: Within time setting range	Use counter and timer in common
31008(03EF)				
31009(03F0)	04	PS1 setting value	Counter 6digit type: -99999 to 999999 4digit type: -999 to 9999 Timer: Within time setting range	Use counter and timer in common
31010(03F1)				
31011(03F2)	04	Setting value of BATCH counter	0 to 999999	Use counter and timer in common
31012(03F3)				
31013(03F4)	04	Checking the input logic	0: NPN, 1 : PNP	

● Date format of 31001(03E8) address bit

Bit 15	Bit 14	Bit 13	Bit 12	Bit 11	Bit 10	Bit 9	Bit 8	Bit 7	Bit 6	Bit 5	Bit 4	Bit 3	Bit 2	Bit 1	Bit 0
CNT	TMR	PS1	PS2	LOCK	BA.S	—	—	OUT1	OUT2	BA.O	—	—	—	—	—
0 or 1	0 or 1	0 or 1	0 or 1	0 or 1	0 or 1	0	0	0 or 1	0 or 1	0 or 1	0	0	0	0	0

※2 Words data format: Upper data has high number address.

Ex)31004 : Present Value(Low Word),
31005 : Present Value(High Word)

5) Preset value setting group

No(Address)	Func	Explanation	Setting range	Notice
40001(0000)	03 06 16	PS2 setting value PS setting value	Counter 6digit type: 0 to 999999	Use counter and timer in common
40002(0001)				
40003(0002)	03 06 16	PS1 setting value	4digit type: 0 to 9999 Timer: Within time setting range	Use counter and timer in common
40004(0002)				
40005(0004)	03 06 16	BATCH counter setting value	0 to 999999	Use counter and timer in common
40006(0005)				

Programmable Counter/Timer

6) Function setting mode (Counter group)

No(Address)	Func	Explanation	Setting range	Notice
40051(0032)	03/06/16	Counter/Timer($\bar{C} - \bar{t}$)	1: $\bar{C} \bar{o} \bar{U} \bar{n}$ 1: $\bar{t} \bar{i} \bar{n} \bar{E}$	Use counter and timer in common
40052(0033)	03/06/16	Input mode($\bar{i} \bar{n}$)	0: $\bar{U} \bar{P}$ 5: $\bar{d} \bar{n} - \bar{2}$ 1: $\bar{U} \bar{P} - \bar{1}$ 6: $\bar{U} \bar{d} - \bar{A}$ 2: $\bar{U} \bar{P} - \bar{2}$ 7: $\bar{U} \bar{d} - \bar{b}$ 3: $\bar{d} \bar{n}$ 8: $\bar{U} \bar{d} - \bar{C}$ 4: $\bar{d} \bar{n} - \bar{1}$	—
40053(0034)	03/06/16	Indication mode($\bar{d} \bar{i} \bar{S} \bar{n}$)	0: $\bar{t} \bar{o} \bar{t} \bar{A} \bar{L}$ 1: $\bar{H} \bar{o} \bar{L} \bar{d}$	For the indicator
40054(0035)	03/06/16	Output mode($\bar{o} \bar{U} \bar{t} \bar{n}$)	0: \bar{F} 3: \bar{r} 6: \bar{A} 9: \bar{t} 1: \bar{n} 4: \bar{E} 7: \bar{A} 10: \bar{d} 2: \bar{C} 5: \bar{P} 8: \bar{S}	—
40055(0036)	03/06/16	Maximum counting speed($\bar{C} \bar{P} \bar{S}$)	0: $\bar{1}$ 2: $\bar{1} \bar{E}$ 4: $\bar{1} \bar{0} \bar{E}$ 1: $\bar{3} \bar{0}$ 3: $\bar{5} \bar{E}$	—
40056(0037)	03/06/16	OUT2(OUT) output time	0000 ~ 9999	unit: ×10ms
40057(0038)	03/06/16	OUT1 Output time	0000 ~ 9999	unit: ×10ms
40058(0039)	03/06/16	Decimal point($\bar{d} \bar{P}$)	0: ----- 2: ----- 4: ---,----- 1: ----,-- 3: ---,---- 5: -,-----	4digit type 0: ---- 1: ---, 2: --, 3: -,---
40059(003A)	03/06/16	Min. reset time($\bar{r} \bar{S} \bar{t}$)	0: $\bar{1}$ 1: $\bar{2} \bar{0}$	unit: ms
40060(003B)	03/06/16	Prescale decimal point position($\bar{S} \bar{C} \bar{L} \bar{d}$)	0: ----- 3: ----- 5: -,----- 2: ----- 4: ---,-----	4digit type 1: ---, 2: --, 3: -,---
40061(003C)	03/06/16	Prescale value($\bar{S} \bar{C} \bar{L}$)	6digit type: 000000 ~ 999999	Connected with prescale decimal point position
40062(003D)			4digit type: 0000 ~ 9999	
40063(003E)	03/06/16	Start value($\bar{S} \bar{t} \bar{r} \bar{t}$)	6digit type: 000000 ~ 999999	Connected with decimal point position of display value
40064(003F)			4digit type: 0000 ~ 9999	
40065(0040)	03/06/16	Memory protection($\bar{d} \bar{R} \bar{t} \bar{A}$)	0: $\bar{C} \bar{L} \bar{r}$ 1: $\bar{r} \bar{E} \bar{C}$	Use counter and timer in common
40066(0041)	03/06/16	Lock key($\bar{L} \bar{o} \bar{C} \bar{K}$)	0: $\bar{L} \bar{o} \bar{F} \bar{F}$ 1: $\bar{L} \bar{o} \bar{C} \bar{.} \bar{1}$ 2: $\bar{L} \bar{o} \bar{C} \bar{.} \bar{2}$ 3: $\bar{L} \bar{o} \bar{C} \bar{.} \bar{3}$	Use counter and timer in common

7) Function setting mode (Timer group)

No(Address)	Func	Explanation	Setting range	Notice
40101(0064)	03/06/16	Counter/Timer($\bar{C} - \bar{t}$)	0: $\bar{C} \bar{o} \bar{U} \bar{n}$ 1: $\bar{t} \bar{i} \bar{n} \bar{E}$	Use counter and timer in common
40102(0065)	03/06/16	Time range ($\bar{H} \bar{o} \bar{U} \bar{r} / \bar{n} \bar{i} \bar{n} / \bar{S} \bar{E} \bar{C}$)	4digit type 0: 0.001s to 9.999s 5: 0.1m to 999.9m 1: 0.01s to 99.99s 6: 1m to 9999m 2: 0.1s to 999.9s 7: 1m to 99h59m 3: 1s to 9999s 8: 1h to 9999h 4: 1s to 99m59s	—
			6digit type 0: 0.001s to 999.999s 6: 1s to 9999m59s 1: 0.01s to 9999.99s 7: 1m to 99999.9m 2: 0.1s to 99999.9s 8: 1m to 999999m 3: 1s to 999999s 9: 1s to 99h59m59s 4: 0.01s to 99m59.99s 10: 1m to 9999h59m 5: 0.1s to 999m59.9s 11: 0.1h to 99999.9h	
40103(0066)	03/06/16	UP/Down mode ($\bar{U} - \bar{d}$)	0: $\bar{U} \bar{P}$ 1: $\bar{d} \bar{n}$	—
40104(0067)	03/06/16	Output mode ($\bar{o} \bar{U} \bar{t} \bar{n}$)	0: $\bar{o} \bar{n} \bar{d}$ 3: $\bar{F} \bar{L} \bar{E}$ 7: $\bar{i} \bar{n} \bar{t} \bar{.} \bar{1}$ 10: $\bar{n} \bar{F} \bar{d}$ 1: $\bar{o} \bar{n} \bar{d} \bar{.} \bar{1}$ 4: $\bar{F} \bar{L} \bar{E} \bar{.} \bar{1}$ 8: $\bar{i} \bar{n} \bar{t} \bar{.} \bar{2}$ 11: $\bar{n} \bar{F} \bar{d} \bar{.} \bar{1}$ 2: $\bar{o} \bar{n} \bar{d} \bar{.} \bar{2}$ 5: $\bar{F} \bar{L} \bar{E} \bar{.} \bar{2}$ 9: $\bar{o} \bar{F} \bar{d}$ 12: $\bar{i} \bar{n} \bar{t} \bar{.} \bar{0}$	—
40105(0068)	03/06/16	OUT2(OUT) Output time ($\bar{o} \bar{U} \bar{t} \bar{.} \bar{2}$)	0000 to 9999 (0: Hold)	unit: ×10ms
40106(0069)	03/06/16	OUT1 Output time ($\bar{o} \bar{U} \bar{t} \bar{.} \bar{1}$)	0000 to 9999 (0: Hold)	unit: ×10,ms
40107(006A)	03/06/16	Input signal time($\bar{i} \bar{n} \bar{t}$)	0: $\bar{1}$ 1: $\bar{2} \bar{0}$	unit: ms
40108(006B)	03/06/16	Memory protection($\bar{d} \bar{R} \bar{t} \bar{A}$)	0: $\bar{C} \bar{L} \bar{r}$ 1: $\bar{r} \bar{E} \bar{C}$	Use counter and timer in common
40109(006C)	03/06/16	Lock key($\bar{L} \bar{o} \bar{C} \bar{K}$)	0: $\bar{L} \bar{o} \bar{F} \bar{F}$ 1: $\bar{L} \bar{o} \bar{C} \bar{.} \bar{1}$ 2: $\bar{L} \bar{o} \bar{C} \bar{.} \bar{2}$ 3: $\bar{L} \bar{o} \bar{C} \bar{.} \bar{3}$	Use counter and timer in common
40110(006D)	03/06/16	Indication mode($\bar{d} \bar{S} \bar{P} \bar{n}$)	0: $\bar{t} \bar{o} \bar{t} \bar{A} \bar{L}$ 1: $\bar{H} \bar{o} \bar{L} \bar{d}$ 2: $\bar{o} \bar{n} \bar{t} \bar{.} \bar{d}$	For the indicator

(A) Photo electric sensor

(B) Fiber optic sensor

(C) Door/Area sensor

(D) Proximity sensor

(E) Pressure sensor

(F) Rotary encoder

(G) Connector/Socket

(H) Temp. controller

(I) SSR/Power controller

(J) Counter

(K) Timer

(L) Panel meter

(M) Tacho/Speed/Pulse meter

(N) Display unit

(O) Sensor controller

(P) Switching mode power supply

(Q) Stepper motor& Driver&Controller

(R) Graphic/Logic panel

(S) Field network device

(T) Software

(U) Other

8) Function setting mode (Communication group)

No(Address)	Func	Explanation	Setting range	Notice
40151(0096)	03/06/16	Com. address (<i>Addr</i>)	1 to 127	—
40152(0097)	03/06/16	Com. speed (<i>bP5</i>)	0:24 1:48 2:96 3:192 4:384	unit: ×100bps
40153(0098)	03/06/16	Com. parity (<i>Prty</i>)	0:none 1:Even 2:odd	—
40154(0099)	03/06/16	Stop bit (<i>StP</i>)	0:1 1:2	—
40155(009A)	03/06/16	Response waiting time (<i>rStt</i>)	05 to 99	unit: ms
40156(009B)	03/06/16	Com. writing (<i>Wrn</i>)	0:EnR 1:d5R	—

⊙ Exception processing

When communication error occurs, the highest bit of received function is set to 1, then sends response command and transmits exception code.

Slave Address	Function+80H	Exception Code	Error Check(CRC16)	
			Low	High
1Byte	1Byte	1Byte	1Byte	1Byte

- Illegal Function(Exception Code: 01H): Not supporting command
- Illegal Data Address(Exception Code: 02H): Mismatch between the number of asked data and the number of transmittable data.
- Illegal Data Value(Exception Code: 03H): Mismatch between asked the number of data and transmittable the number of data in device
- Slave Device Failure(Exception Code: 04H): Command is processed incorrectly.

Example

Master reads output status (ON:1, OFF:0) of non existing coil 01001 (03E8 H) from Slave (Address17).

• Query(Master)

Slave Address	Function	Starting Address		No. of Points		Error Check(CRC16)	
		High	Low	High	Low	Low	High
11H	01H	03H	E8H	00H	01H	##H	##H

• Response(Slave)

Slave Address	Function + 80H	Exception Code	Error Check(CRC16)	
			Low	High
11H	81H	02H	##H	##H

■ Read and write of parameter value using communication

⊙ Read of the parameter area

00002(OUT2), 00003(OUT1), 00004(BA, 0), 10001 to 10005(Terminal input), 30101 to 30125(Product information), 31001 to 31013(Monitoring data)

⊙ Read and write of the parameter area

00001(Reset starts), 00005(BATCH Reset starts), 40001 to 40006(Setting value saving group), 40051 to 40066(Counter setting group), 40101 to 40110(Timer setting group), 40151 to 40156(Communication setting group)

⊙ Read of communication

Read parameter value using communication.(Function : 01H, 02H, 03H, 04H)

It is able to read communication regardless of permitting/prohibiting communication writing.

⊙ Communication write

Change parameter value using communication.(Function: 05H, 06H, 10H)

- When change the parameter setting value of 'Function setting mode Counter group' or 'Function setting mode Timer group' using communication, reset indication will flash in 3 sec. and display value will be reset.(Counting display value and progress time before changing parameter setting value are not saved.)
- When change the parameter setting value of 'Preset value setting group' or 'Function setting mode Communication group' using communication, counting display value or progress time will not be reset.
- In prohibit writing communication setting (*Wrn* = 1:d5R), a write command does not process.
- If set value beyond the setting range, this setting value is substituted for the value within the setting range and then memorized.

■ Proper usage

○ The power ON/OFF

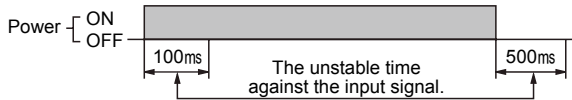

Power voltage rises for 100ms after power on and falls for 500ms after power off. Therefore be sure to apply input signal after 100ms and power turns on again after 500ms when power turns off.

- Be sure to use insulated and resistive voltage /current or Class2 supply power device to input 24VAC/24-48VDC power supply model.

○ Input signal line

- Use as short a cable from the sensor to this unit as possible.
- Use shielded cable for long input line.
- Wire as separating input line from the power line.

○ When selecting input logic

Be sure that supply power is off when selecting input logic, then select logic input according to input logic changing method.

○ Contact count input (When it is used as Counter)

If apply contact input at high speed mode(1k, 5k, 10k), it may cause miscount by chattering. Therefore set low speed mode(1cps or 30cps) at contact input.

○ When test dielectric voltage and insulation resistance of the control panel with this unit installed.

- Please isolate this unit from the circuit of control panel.
- Please make all terminals of this unit short-circuited.

○ Do not use below places.

- Place where there are severe vibration or impact.
- Place where strong alkalis or acids are used.
- Place where there are direct ray of the sun.
- Place where strong magnetic field or electric noise are generated.

○ Installation environment

- It shall be used indoor.
- Altitude Max. 2000m
- Pollution Degree 2
- Installation Category II

(A)	Photo electric sensor
(B)	Fiber optic sensor
(C)	Door/Area sensor
(D)	Proximity sensor
(E)	Pressure sensor
(F)	Rotary encoder
(G)	Connector/Socket
(H)	Temp. controller
(I)	SSR/ Power controller
(J)	Counter
(K)	Timer
(L)	Panel meter
(M)	Tacho/ Speed/ Pulse meter
(N)	Display unit
(O)	Sensor controller
(P)	Switching mode power supply
(Q)	Stepper motor& Driver&Controller
(R)	Graphic/ Logic panel
(S)	Field network device
(T)	Software
(U)	Other